

# FORKARDT

*SDC*

*Industrial shock absorbers -  
self adjusting*



WORKHOLDING SOLUTIONS WORLDWIDE

# INDUSTRIAL SHOCK ABSORBERS

## General

Increased automation in all branches of industry has resulted in higher handling and working speeds.

The resultant kinetic energy, however, rises with the square of the speed.

## High kinetic energy can result in:

- damage
- destruction
- production stoppages
- repairs
- noise
- as well as costs arising from these causes.

Costs arising from uncontrolled kinetic energy can however be avoided.

FORKARDT industrial shock absorbers absorb kinetic energy and stop moving objects gently and reliably.

The retardation forces are thereby reduced, and can be calculated.

FORKARDT has created an entirely new generation of shock absorbers, based on its wide experience in this field.

The SDC series consists of "self adjusting" shock absorbers which automatically compensate the effects of mass, speed and actuating force during the retardation process.

SDC shock absorbers can achieve linear retardation with a constant retarding force under favourable loading conditions.

## In practice this means:

- low retardation forces
- improved dynamic performance
- higher productivity
- simpler designs
- simpler controls
- noise reduction
- less power consumption
- greater economy
- cost reduction

With the SDC series FORKARDT offers an at present unsurpassed, comprehensive and high performance range of "self adjusting" industrial shock absorbers, i. e. a range of high grade, long lasting and yet low cost hydraulic dampers.

## Advantages

All series SDC shock absorbers are:

- self adjusting
  - universally applicable
  - cost effective
- and feature:**
- high energy absorption
  - high safety margins
  - high reliability
  - prolonged service
  - metric dimensions
  - product quality to traditionally high German standards



FORKARDT shock absorbers are outstandingly versatile, irrespective of whether it is necessary to arrest masses of a few grammes or many tons, or whether they are used in laboratories or rolling mills.

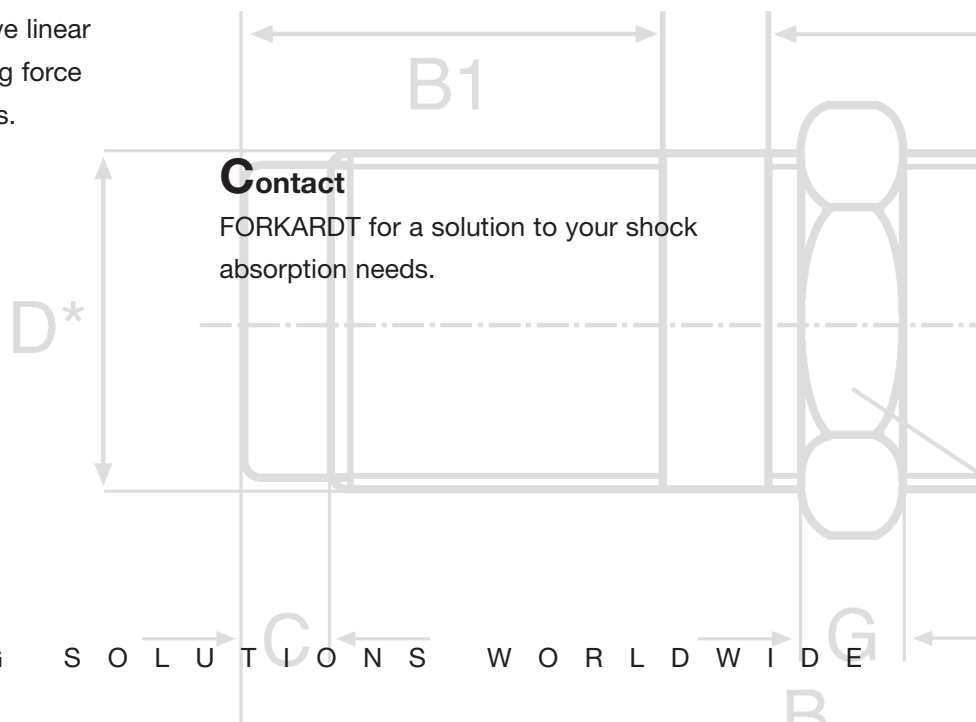

## Contact

FORKARDT for a solution to your shock absorption needs.

## Fields of application:

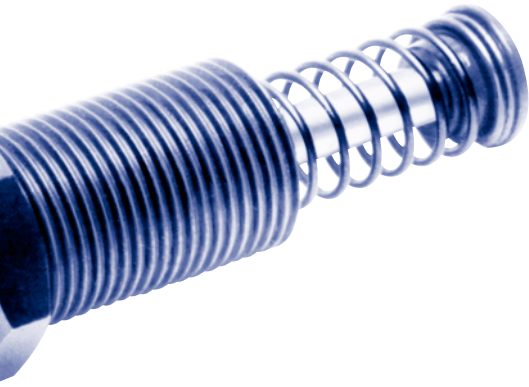

FORKARDT - Industrial Shock Absorbers		
for arresting	to facilitate	for use on
workpieces	automation	handling equipment
strips	machining	industrial robots
plates	forming	linear handling units
slabs	loading	rotary handling units
bars	unloading	machine tools
tubes	gripping	plastics processing machines
springs	lifting	textile machines
levers	lowering	packing machines
covers	swivelling	paper making machines
flaps	positioning	welding plants
doors	conveying	mechanisms
gates	closing	transfer equipment
windows	sorting	conveyors and elevators
frames	stacking	manipulators
guards	bundling	wood working machines
gate valves	indexing	linking
sildes	handling	feeding
carriages	machine	
cylinders	linking	

## Performance data

Type	Piston dia. $\phi$ mm	Stroke mm	Perm. energy absorption		Equivalent mass $m_w$		Return spring force		Permissible inclination of load $^\circ$	Weight approx. kg
			per stroke Nm/stroke	per hour kNm/h	from kg	to kg	min. N	max. N		
SDC 7 - 13 W	7	13	17	36	1	10	4,5	11	4	0.06
SDC 7 - 13 M					10	100				
SDC 7 - 13 H					100	200				
SDC 10 - 13 W	10	13	30	46	3	25	10	19	4	0.14
SDC 10 - 13 M					25	250				
SDC 10 - 13 H					200	650				
SDC 10 - 25 W	10	25	60	58	6	55	8	20	3	0.17
SDC 10 - 25 M					410	1,330				
SDC 10 - 25 H					8	70				
SDC 12 - 25 W	12	25	80	70	70	650	11	21	3	0.27
SDC 12 - 25 M					550	1,700				
SDC 12 - 25 H					15	140				
SDC 12 - 50 W	12	50	160	92	140	1,300	14	26	2	0.38
SDC 12 - 50 M					1,000	3,500				
SDC 12 - 50 H					10	90				
SDC 14 - 25 W	14	25	100	80	90	800	29	50	4	0.44
SDC 14 - 25 M					680	2,000				
SDC 14 - 25 H					20	180				
SDC 14 - 50 W	14	50	200	105	180	1,600	26	56	3	0.54
SDC 14 - 50 M					1,300	4,400				
SDC 14 - 50 H					30	260				
SDC 14 - 75 W	14	75	300	130	260	2,400	26	60	2	0.70
SDC 14 - 75 M					2,000	6,600				
SDC 14 - 75 H					20	200				
SDC 18 - 25 W	18	25	225	120	200	1,800	56	76	4	0.80
SDC 18 - 25 M					1,500	5,000				
SDC 18 - 25 H					40	400				
SDC 18 - 50 W	18	50	450	150	400	3,600	36	76	3	0.94
SDC 18 - 50 M					3,000	10,000				
SDC 18 - 50 H					60	600				
SDC 18 - 75 W	18	75	675	180	600	5,500	38	76	2	1.15
SDC 18 - 75 M					4,500	15,000				
SDC 18 - 75 H					40	400				
SDC 25 - 25 W	25	25	450	165	400	3,600	83	115	5	1.43
SDC 25 - 25 M					3,000	10,000				
SDC 25 - 25 H					80	800				
SDC 25 - 50 W	25	50	900	200	800	7,300	50	115	4	1.64
SDC 25 - 50 M					6,000	20,000				
SDC 25 - 50 H					130	1,200				
SDC 25 - 75 W	25	75	1350	235	1,200	11,000	48	106	3	1.91
SDC 25 - 75 M					9,000	30,000				
SDC 25 - 75 H					170	1,600				
SDC 25 - 100 W	25	100	1800	270	1,600	14,500	50	115	2	2.30
SDC 25 - 100 M					12,000	40,000				
SDC 25 - 100 H										

## Dimensions / calculations

### Shock absorber

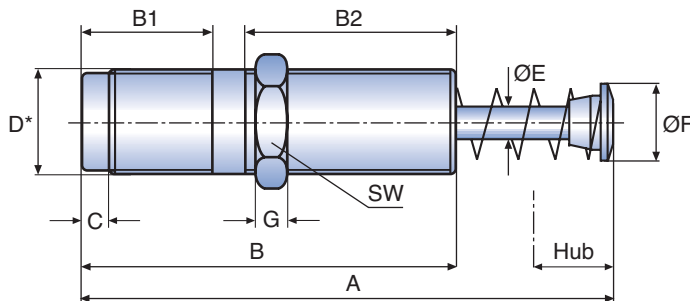

### Flange (optional)

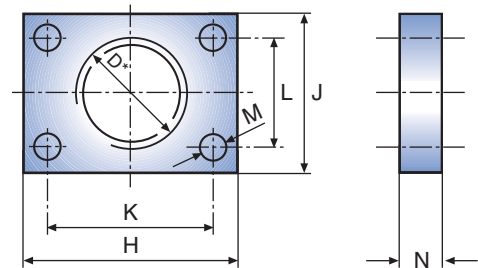

The thread „D“ is not full length from SDC 14 onwards  
Other dimensions required will be supplied on request.

## Performance data

Type SDC	A	B	Thread length		C	D*	Special threads available on request	ø E	ø F	G	SW	Flange					
			B1	B2								H	J	K	L	ø M	N
7 - 13	87	66	overall length		7.0	M14 x 1.5	M14 x 1.0 M16 x 1.5	5	11	5	17	35	25	27	17	4.5	10
10 - 13	100	74	overall length		7.0	M20 x 1.5	M20 x 1.0	6	15	6	24	40	30	32	22	4.5	12
10 - 25	138	97	overall length		7.0	M20 x 1.5	M20 x 1.0	6	15	6	24	40	30	32	22	4.5	12
12 - 25	143	102	overall length		7.0	M24 x 1.5	M25 x 1.5 M27 x 1.5 M27	8	19	8	30	50	35	40	25	5.5	12
12 - 50	227	147	overall length		7.0	M24 x 1.5	M25 x 1.5 M27 x 1.5 M27	8	19	8	30	50	35	40	25	5.5	12
14 - 25	138	83		40							fluted nut ø 38						
14 - 50	189	108	27.0	65	2.0	M32 x 1.5	M33 x 1.5	8	25	6	fluted nut ø 38	45	45	35	35	6.5	8
14 - 75	255	133		90							fluted nut ø 38						
18 - 25	146	95		40							fluted nut ø 50						
18 - 50	196	120	35.5	60	2.5	M42 x 1.5	M45 x 1.5	12	33	6	fluted nut ø 50	65	65	50	50	9.0	12
18 - 75	246	145		70							fluted nut ø 50						
25 - 25	155	105		45							fluted nut ø 62						
25 - 50	205	130	40.0	70							fluted nut ø 62						
25 - 75	265	155		90	4.0	M52 x 1.5		16	40	8	fluted nut ø 62	70	70	55	55	9.0	12
25 - 100	334	180		110							fluted nut ø 62						

\* Standard threads are preferable. Do not use special threads for new designs. Provide dead stop 0.5 to 1 mm prior to end of stroke. Dimensions in mm. Dimensions may be changed without prior notice. Shock absorbers may be fitted in any position. Temperature range: 0° to 80°C (other temperature ranges available on request). Other mounting styles, e.g. foot and clevis mounting, available on request.

### Example of order code

Type \_\_\_\_\_ SDC 10 - 25 W  
Piston dia. \_\_\_\_\_  
Stroke \_\_\_\_\_  
Damping action \_\_\_\_\_

	Degree of hardness	Characterisation (see dimension C)
W	Soft	red bottom
M	Medium	yellow bottom
H	Hard	blue bottom

# Formular and specimen calculations

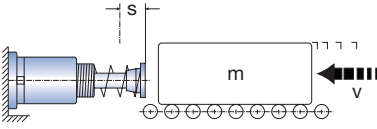
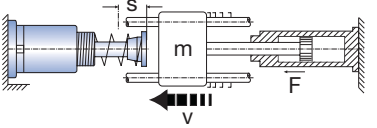
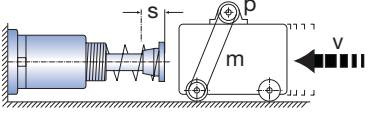
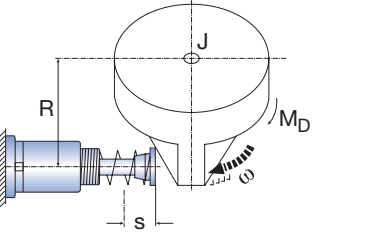
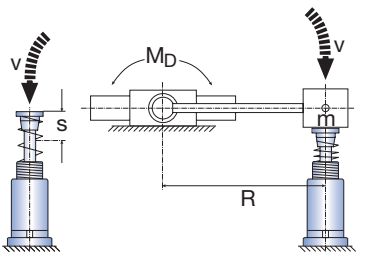
Example	Loading conditions	Equations	Calculations / choice
<b>Mass without externally applied force</b> 	$m = 15 \text{ kg}$ $v = 1,8 \text{ m/s}$ $Z = 640$	$W_K = \frac{m \cdot v^2}{2}$ $W_H = W_K \cdot Z$ $m_W = m$	$W_K = \frac{15 \cdot 1,8^2}{2} = 24,3 \text{ Nm}$ $W_H = 24,3 \cdot 640 = 15552 \text{ Nm/h}$ $m_W = 15 \text{ kg}$
	<b>required:</b> $W_K, W_H, m_W$		<b>choice:</b> SDC 10 - 13 W or: SDC 25 - 25 W
<b>Mass with externally applied force</b> 	$m = 20 \text{ kg}$ $v = 2 \text{ m/s}$ $F = 2000 \text{ N}$ $s = 0,025 \text{ m}$ $Z = 480$	$W_G = \frac{m \cdot v^2}{2} + F \cdot s$ $W_H = W_G \cdot Z$ $m_W = \frac{W_G \cdot 2}{v^2}$	$W_G = \frac{20 \cdot 2^2}{2} + 2000 \cdot 0,025 = 90 \text{ Nm}$ $W_H = 90 \cdot 480 = 43200 \text{ Nm/h}$ $m_W = \frac{90 \cdot 2}{2^2} = 45 \text{ kg}$
	<b>required:</b> $W_G, W_H, m_W$		<b>choice:</b> SDC 14 - 25 M
<b>Motor driven mass</b> 	$m = 100 \text{ kg}$ $v = 1 \text{ m/s}$ $P = 2 \text{ kW}$ $s = 0,025 \text{ m}$ $H_M = 2,5$ $Z = \text{Notfall}$	$W_K = \frac{m \cdot v^2}{2}$ $A = \frac{P \cdot s \cdot 1000 \cdot H_M}{v}$ $W_G = W_K + A$ $m_W = \frac{W_G \cdot 2}{v^2}$	$W_K = \frac{100 \cdot 1^2}{2} = 50 \text{ Nm}$ $A = \frac{2 \cdot 0,025 \cdot 1000 \cdot 2,5}{1} = 125 \text{ Nm}$ $W_G = 50 + 125 = 175 \text{ Nm}$ $m_W = \frac{175 \cdot 2}{1^2} = 350 \text{ kg}$
	<b>required:</b> $W_K, A, W_G, m_W$		<b>choice:</b> SDC 18 - 25 M SDC 25 - 25 W
<b>Rotating mass</b> 	$J = 48 \text{ kgm}^2$ $\omega = 0,5 \text{ s}^{-1}$ $M_D = 630 \text{ Nm}$ $R = 0,3 \text{ m}$ $s = 0,025 \text{ m}$ $Z = 70$	$W_K = \frac{J \cdot \omega^2}{2}$ $A = \frac{M_D}{R} \cdot s$ $W_G = W_K + A$ $W_H = W_G \cdot Z$ $m_W = \frac{W_G \cdot 2}{v^2}$	$W_K = \frac{48 \cdot 0,5^2}{2} = 6 \text{ Nm}$ $A = \frac{630}{0,3} \cdot 0,025 = 52,5 \text{ Nm}$ $W_G = 6 + 52,5 = 58,5 \text{ Nm}$ $W_H = 58,5 \cdot 70 = 4095 \text{ Nm/h}$ $m_W = \frac{58,5 \cdot 2}{0,5^2} = 468 \text{ kg}$
	<b>required:</b> $W_K, A, W_G, W_H, m_W$		<b>choice:</b> SDC 10 - 25 H
<b>Mass with swivel drive</b> 	$m = 56 \text{ kg}$ $v = 0,4 \text{ m/s}$ $M_D = 1200 \text{ Nm}$ $R = 0,5 \text{ m}$ $s = 0,025 \text{ m}$ $Z = 120$	$W_K = \frac{m \cdot v^2}{2}$ $A = \frac{M_D}{R} \cdot s$ $W_G = W_K + A$ $W_H = W_G \cdot Z$ $m_W = \frac{W_G \cdot 2}{v^2}$	$W_K = \frac{56 \cdot 0,4^2}{2} = 4,5 \text{ Nm}$ $A = \frac{1200}{0,5} \cdot 0,025 = 60 \text{ Nm}$ $W_G = 4,5 + 60 = 64,5 \text{ Nm}$ $W_H = 64,5 \cdot 120 = 7740 \text{ Nm/h}$ $m_W = \frac{64,5 \cdot 2}{0,4^2} = 806 \text{ kg}$
	<b>required:</b> $W_K, A, W_G, W_H, m_W$		<b>choice:</b> SDC 12 - 25 H SDC 18 - 25 M

## Accessories for shock absorbers

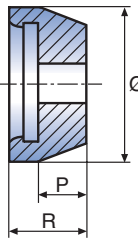

**Striker cap**  
for fitting to piston rod end  
**Advantage:**  
noise reduction  
Material: nylon

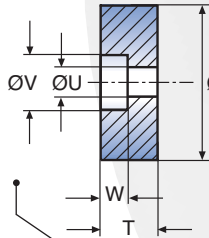

**Striker plate**  
for bolting to the part to be arrested  
**Advantage:**  
noise reduction  
Material: nylon

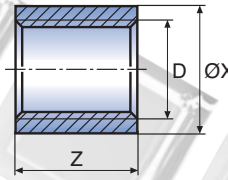

**Dead stop**  
for screwing on the shock absorber body  
**Advantage:**  
no external stop required  
Material: steel, phosphated

SDC	Ident. No.	Ø O	P	R	Ident. No.	Ø S	T	Ø U	Ø V	W	Ident. No.	D	Ø X	Z
7-13	82210090	14	5	10	82000091	12	8	3.2	6	3,5	82210092	M14 x 1.5	18	25
10-13, 25	82010090	20	6	11	82010091	16	8	3.2	6	3,5	82010092	M20 x 1.5	25	30
12-25, 50	82030090	24	8	13	82030091	20	10	4.2	7.5	5	82030092	M24 x 1.5	32	50
14-25, 50, 75	81000090	30	10	16	81000091	25	10	4.2	7.5	5	81000092	M32 x 1.5	38	69
18-25, 50, 75	81100090	38	15	21	81100091	32	12	5.5	9.5	6	81100092	M42 x 1.5	50	65
25-25,50/75,100	81200090	46	20	27	81200091	40	12	5.5	9.5	6	81200092	M52 x 1.5	62	65/95

### Explanatory note on effective mass $m_w$

The effective mass has to be calculated to ensure optimum operation of the self adjusting shock absorber. This is a virtual mass and is calculated from the kinetic energy/stroke ( $W_G$ ) and the impact velocity. If purely kinetic energy has to be absorbed, then the effective mass corresponds to the actual mass ( $m_w = m$ ).

### Symbols and units employed

$W_K$	= kinetic energy/stroke (excluding work done by drive)	Nm/stroke
$W_G$	= kinetic energy/stroke ( $W_G = W_K + A$ )	Nm/stroke
$W_H$	= kinetic energy/hour ( $W_G$ bzw. $W_K \times Z$ )	Nm/h

$m$	= mass	kg
$m_w$	= effective mass	kg
$v$	= impact velocity	m/s
$s$	= shock absorber stroke	m
$F$	= external force applied	N
$M_D$	= external torque applied	Nm
$A$	= work done by drive ( $F \cdot s$ )	Nm
$P$	= power of drive	kW
$Z$	= number of strokes/hour	
$J$	= polar moment of inertia	kgm <sup>2</sup>
$\omega$	= angular velocity	s <sup>-1</sup>
$R, r$	= radius	m
$H_M$	= overload motor torque (normal: 2.5)	1... 2.5
<b>1 N</b>	= <b>0.102 kp</b>	= <b>9.81 N</b>
<b>1 Nm</b>	= <b>0.102 mkp</b>	= <b>9.81 Nm</b>

## L O C A T I O N S W O R L D W I D E

FORKARDT DEUTSCHLAND GMBH  
Heinrich-Hertz-Str. 7  
D-40699 Erkrath  
Phone: (+49) 211 25 06-0  
Fax: (+49) 211 25 06-221  
E-Mail: info@forkardt.com

FORKARDT FRANCE S.A.R.L.  
28 Avenue de Bobigny  
F-93135 Noisy le Sec Cédex  
Phone: (+33) 1 4183 1240  
Fax: (+33) 1 4840 4759  
E-Mail: forkardt.france@forkardt.com

FORKARDT INDIA LLP  
Plot No. 39 D.No.5-5-35  
Ayyanna Ind. Park  
IE Prasanthnagar, Kukatpally  
Hyderabad - 500 072  
India  
Phone: (+91) 40 400 20571  
Fax: (+91) 40 400 20576  
E-Mail: info@forkardtindia.com

FORKARDT USA  
2155 Traversefield Drive  
Traverse City, MI 49686, USA  
Phone: (+1) 800 544-3823  
(+1) 231 995-8300  
Fax: (+1) 231 995-8361  
E-Mail: sales@forkardt.us  
Website: www.forkardt.us

FORKARDT CHINA  
Precision Machinery (Shanghai) Co Ltd  
1F, #45 Building, No. 209 Taigu Road,  
Waigaoqiao FTZ CHINA 200131,  
CHINA  
Phone: (+86) 21 5868 3677  
E-Mail: info@forkardt.cn.com  
Website: www.forkardt.us

[www.forkardt.com](http://www.forkardt.com)

[www.forkardt.us](http://www.forkardt.us)